

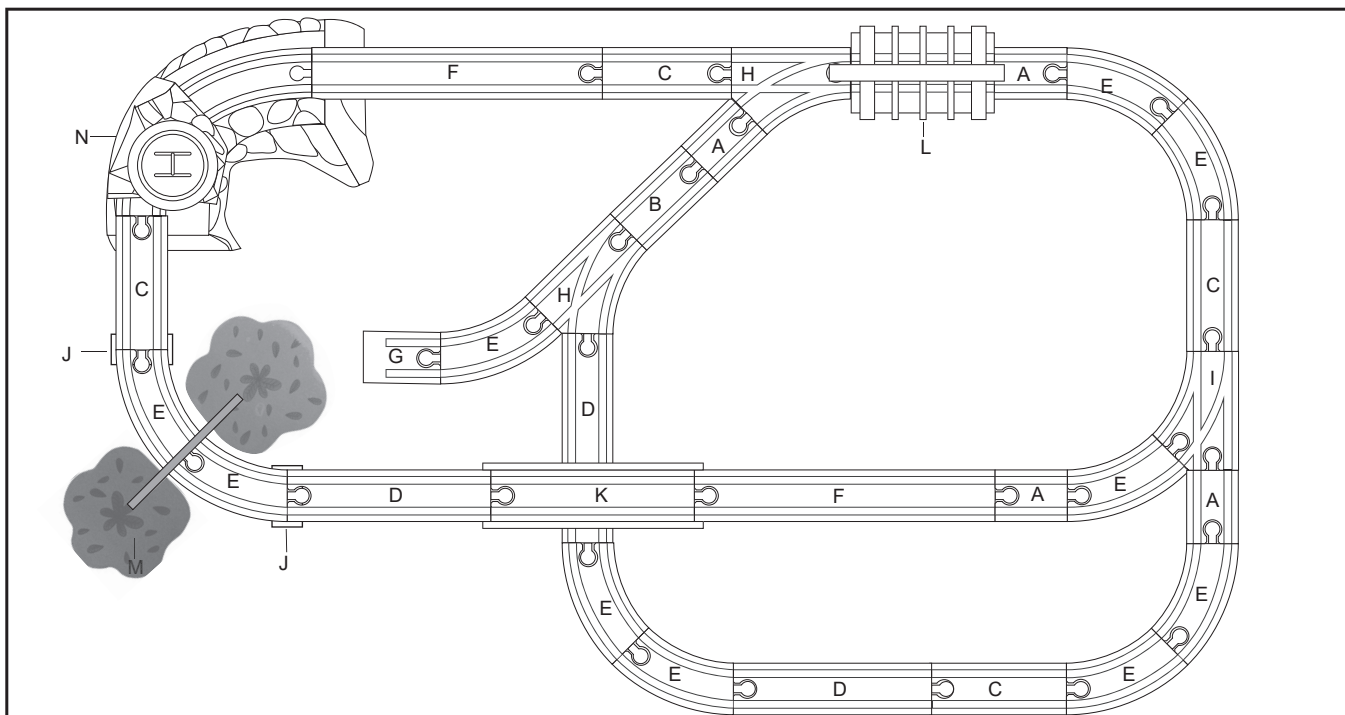











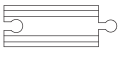
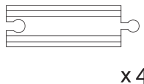
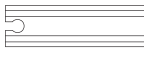
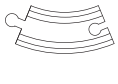

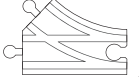
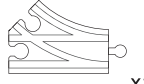
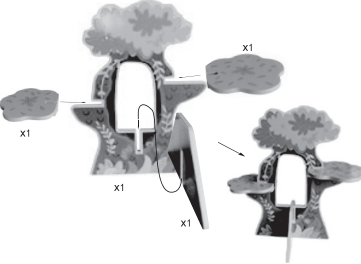
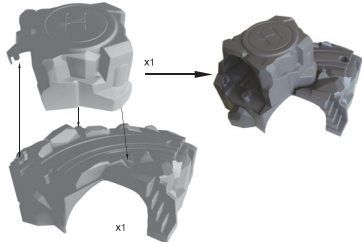















Bartek

PL: Kolejka Ze Stołem Zestaw 80 Elementów
DE: Spielzeugeisenbahn mit dem Tisch Set 80 Elemente
EN: Train Set with Table - 80pc
CZ: Vláček s hracím stolem, sada 80ks
SK: Vláčik s hracím stolom, sada 80ks
LT: Traukinuko rinkinys su stalu - 80 vnt.

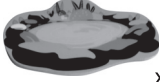
4IQ
group

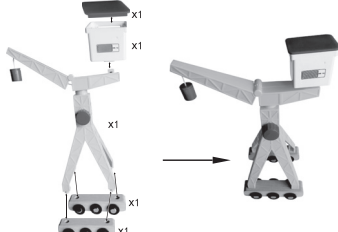
**Instrukcja montażu / Montageanleitung / Assembly Instruction /
Montážní návod / Montážny návod / Surinkimo instrukcija**

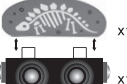

A	B	C	D	E	F	
 x4	 x1	 x4	 x3	 x10	 x2	
G	H	I	M		N	
 x1	 x2	 x1	 x1		 x1	
J	K	L				
 x2	 x1	 x1				
100A	100B	100C	100D	100E	100F	100G
 x1	 x1	 x1	 x1	 x1	 x2	 x1
100H	100I	100J	100K	100L	100M	100N
 x5	 x4	 x4	 x1	 x1	 x1	 x1
100O	100P	100Q	100R	100S	100Y	
 x1	 x1	 x1	 x1	 x1	 x1	
100T	100U	100V	100W	100X		
 x1	 x1	 x1	 x1	 x1		

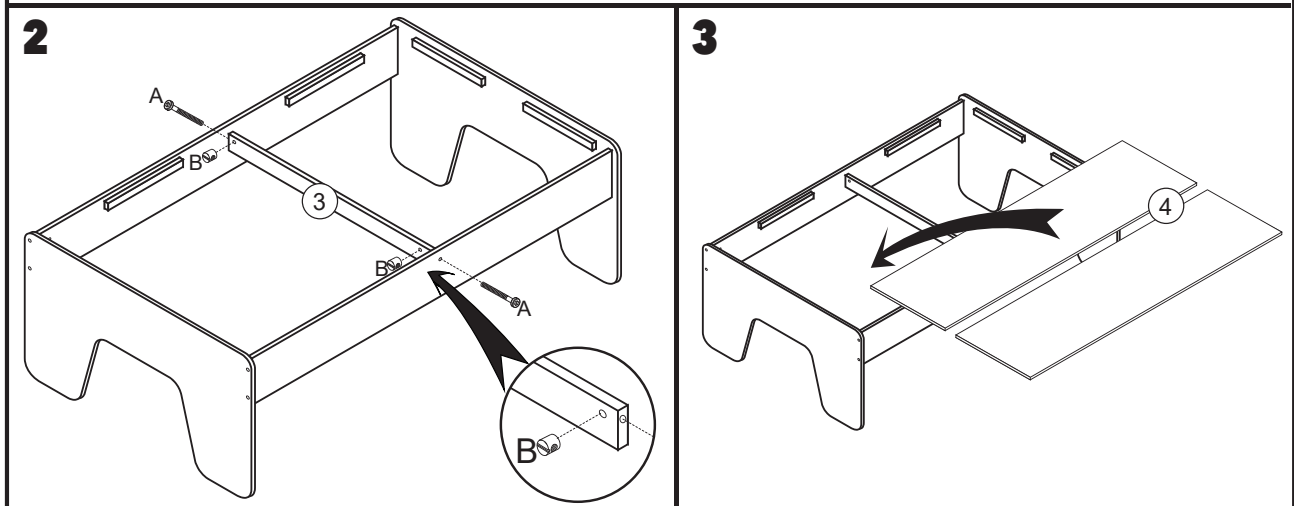
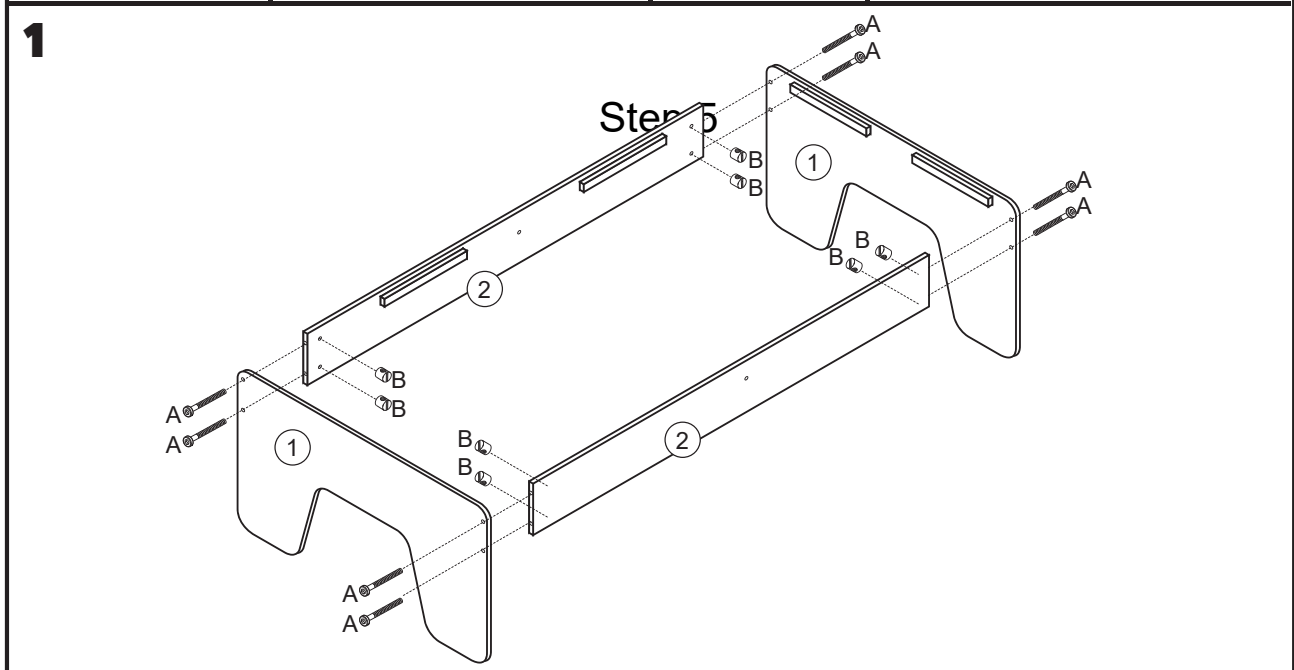
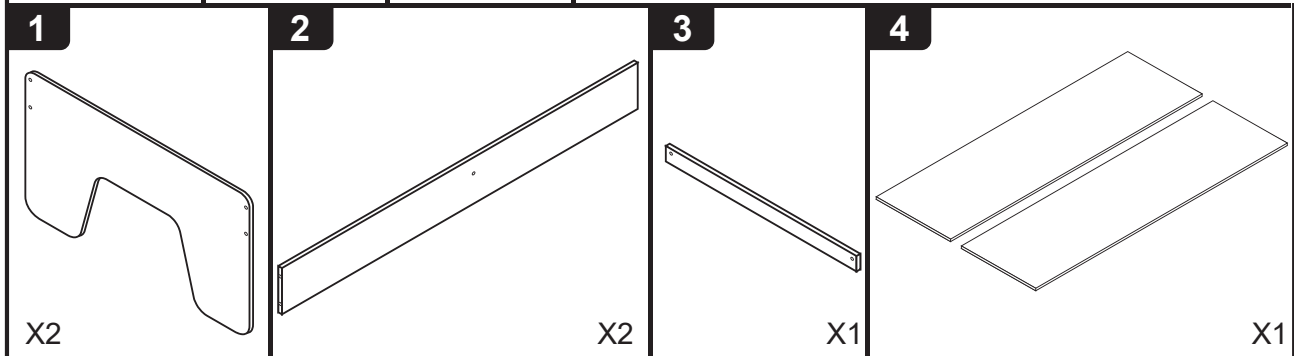
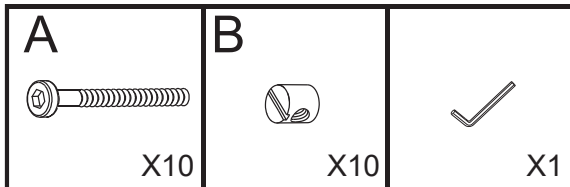

UWAGA!
MAŁE CZĘŚCI
- RYZYKO ZADŁAWIENIA.
 Nie przeznaczone dla dzieci poniżej 3 roku życia.
 Wymagany jest montaż przez osobę dorosłą. Przed użyciem upewnij się, że wszystkie nakrętki i śruby są bezpiecznie zamocowane.
 Zachowaj te informacje.

ACHTUNG!
KLEINE ELEMENTE
- ERSTICKUNGSGEFAHR.
 Für Kinder unter 3 Jahren nicht geeignet. Die Montage muss ein Erwachsener durchführen. Bitte vergewissern Sie sich vor dem Gebrauch, ob alle Schrauben und Mutter sicher befestigt sind. Erhalten Sie diese Informationen.

WARNING!
SMALL PARTS - CHOKING HAZARD.
 Not suitable for children under 3 years.
 Adult assembly required.
 Before use ensure all nuts and bolts are securely fastened.
 Please retain this information.

POZOR!
MAŁE DZIEŁY - NEBEZPEČÍ UDUŠENÍ.
 Není určeno pro děti do 3 let.
 Je nutná montáž jen dospělou osobou. Před použitím se ujistěte, že jsou všechny šrouby a matice bezpečně upevněny. Uchovejte tuto informaci.

POZOR!
MAŁE DZIEŁY - NEBEZPEČENSTWO UDUŠENIA.
 Nie je určené pre deti do 3 rokov.
 Je nutná montáž len dospelou osobou. Pred použitím sa uistite, že sú všetky skrutky a matice bezpečne upevnené. Uchovajte túto informáciu.

DĖMESIO!
SMULKIOS DALYS - PAVOJUS UDUŠENIA.
 Netinka vaikams iki 3 metų.
 Surinkti privalo suaugę.
 Prieš naudojimą būtina patikrinti ar visi tvirtinimo elementai saugiai priveržti.
 Išsaugokite šią informaciją.



„4iQ GROUP“ SP. Z O.O.
 Ul. Ostródzka 54, 14-200 ŁAWA
 tel. +48 89 674 92 57
 WWW.4IQ.COM.PL

